

HOUSING UNITS

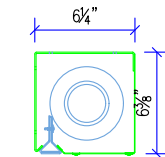

M2100 HOUSING

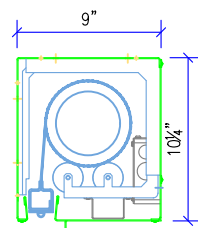

M2500 SMALL HOUSING FOR UNDER 12' CLEAR OPENING HEIGHT

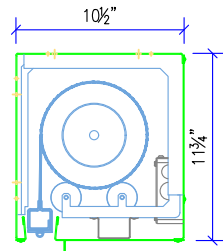

M2500 LARGE HOUSING FOR 12' AND OVER CLEAR OPENING HEIGHT

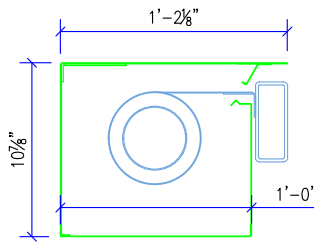

M3000 HEAD BOX HOUSING

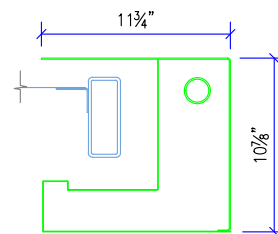

M3000 FOOT BOX HOUSING

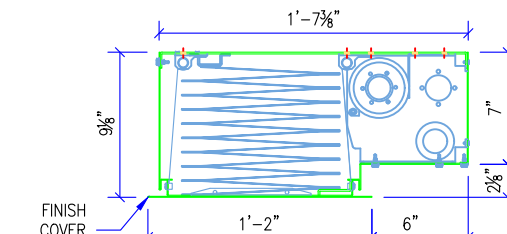

M4000 HOUSING

SCALE: 1" = 1'-0"



287 N. Maple Grove
Boise, ID 83704
800.574.0330
www.smokeguard.com

SIDE GUIDES

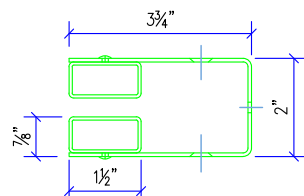

M2100 SIDE GUIDE

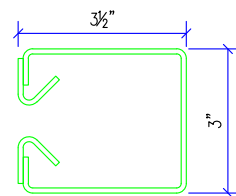

M2500 SIDE GUIDE

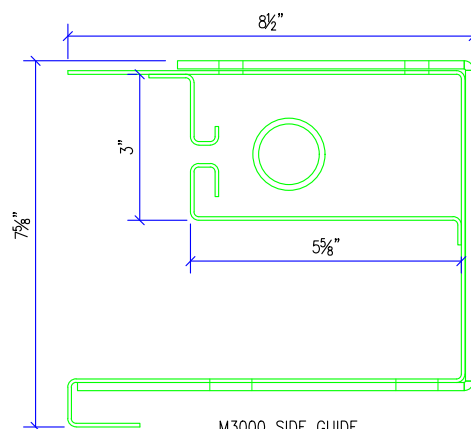

M3000 SIDE GUIDE

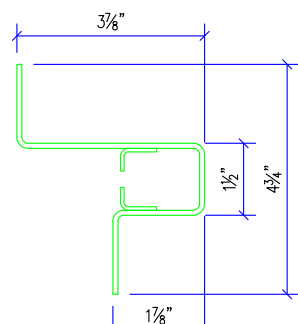

M4000 SIDE GUIDE

SCALE: 3" = 1'-0"

BOTTOM BARS AND LEADING EDGE

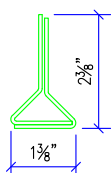

M2100 BOTTOM BAR

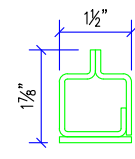

M2500 BOTTOM BAR

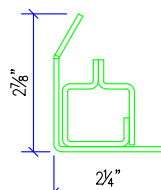

M2500 EGRESS BOTTOM BAR

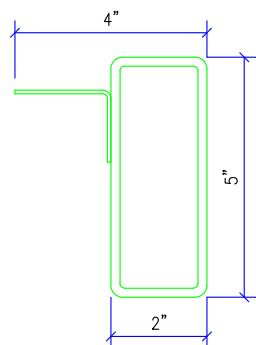

M3000 LEADING EDGE

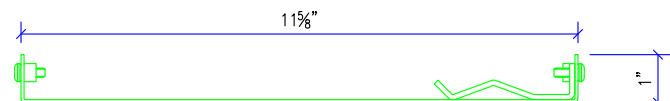

M4000 CURTAIN TRAY

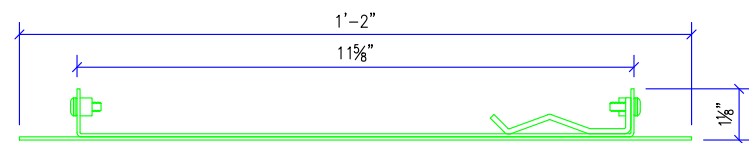

M4000 CURTAIN TRAY W/OPTIONAL 14" FINISH COVER

SCALE: 3" = 1'-0"

HEAD BOX MOUNTING METHODS

FACE MOUNT

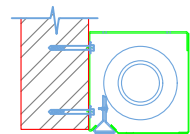

M2100 HOUSING

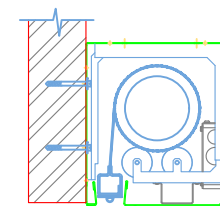

M2500 SMALL HOUSING FOR UNDER 12' CLEAR OPENING HEIGHT

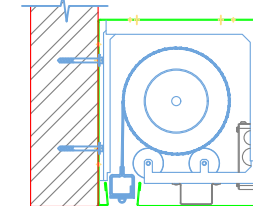

M2500 LARGE HOUSING FOR 12' AND OVER CLEAR OPENING HEIGHT

TOP MOUNT

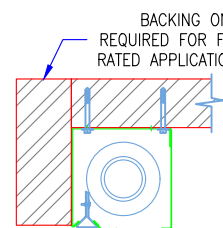

M2100 HOUSING

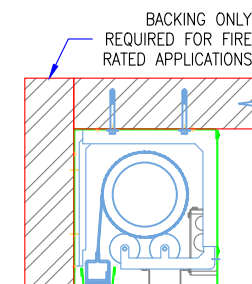

M2500 SMALL HOUSING FOR UNDER 12' CLEAR OPENING HEIGHT

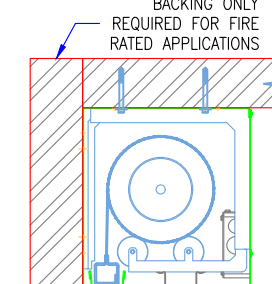

M2500 LARGE HOUSING FOR 12' AND OVER CLEAR OPENING HEIGHT

SCALE: 1" = 1'-0"

SIDE GUIDE MOUNTING STYLES

JAMB MOUNT

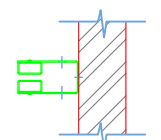

M2100 SIDE GUIDE

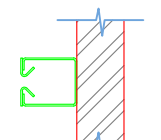

M2500 SIDE GUIDE FOR UNDER 20' - CLEAR OPEN WIDTH

FACE MOUNT

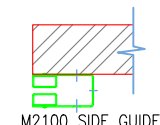

M2100 SIDE GUIDE

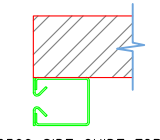

M2500 SIDE GUIDE FOR UNDER 20' - CLEAR OPEN WIDTH

SCALE: 1" = 1'-0"

SMOKE GUARD (VERTICAL, HORIZONTAL, AND PERIMETER) CUT SHEET

REVISION

REVISION NUMBER	REVISION DATE	REVISION DESCRIPTION

DRAWN	NAME	DATE
KDR	KDR	1/25/2018
MODIFIED	KEVINR	2/28/2018
PLOTTED	KEVIN ROGERS	2/28/2018

SHEET TITLE	SIZE
HOUSING AND SIDE GUIDE PROFILES	B SHEET

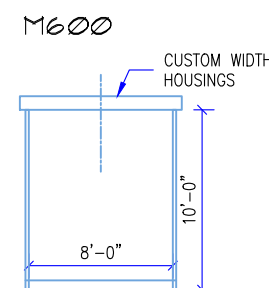
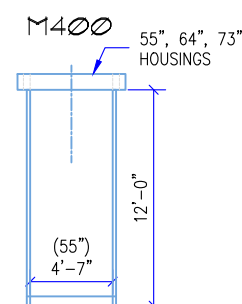
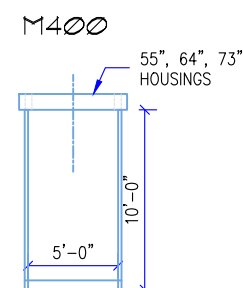
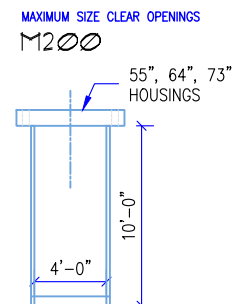
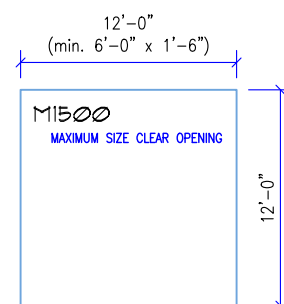
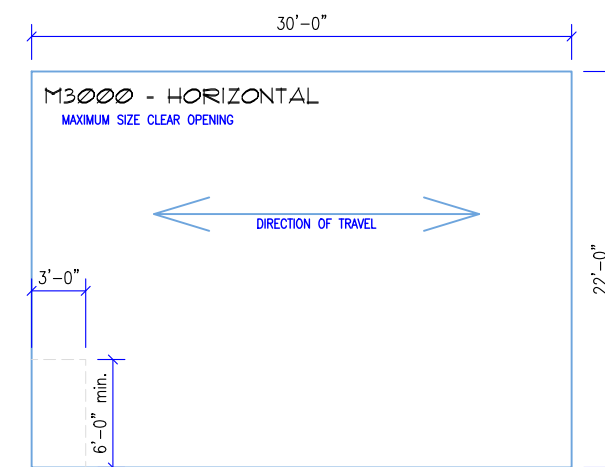
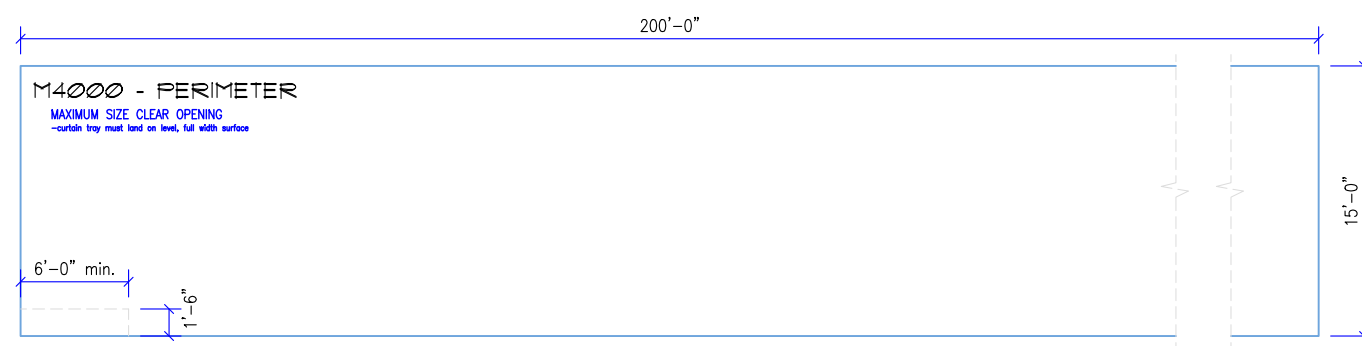
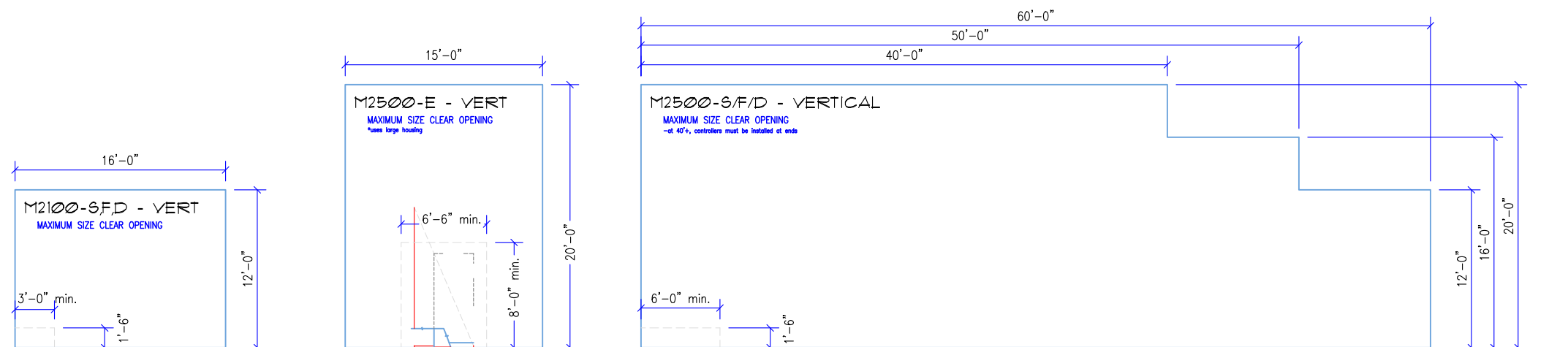

SMOKE GUARD (VERTICAL, HORIZONTAL, AND PERIMETER) CUT SHEET

REVISION

REVISION NUMBER	REVISION DATE	REVISION DESCRIPTION

	NAME	DATE
DRAWN	KDR	1/25/2018
MODIFIED	KEVINR	2/28/2018
PLOTTED	KEVIN ROGERS	2/28/2018

SHEET TITLE	SIZE
ALLOWABLE SIZE RANGES FOR SMOKE GUARD PRODUCTS	B
	SHEET